

# PRODUCT SPECIFICATION

Date : 2003/12/15

COSMO	Photointerrupter :	No.60K00001	REV.
ELECTRONICS CORPORATION	KW1S50FC	Sheet 1 Of 5	1

## Horizontal Slit Type Photointerrupter

### ● Features

1. Horizontal slit type
2. PWB direct mounting type
3. GAP between light emitter and detector : 4.2mm
4. Slit width : 0.5mm
5. With a positioning boss

### ● Applications

1. OA equipment, such as printer etc.

# PRODUCT SPECIFICATION

Date : 2003/12/15

COSMO ELECTRONICS CORPORATION	Photointerrupter : <b>KW1S50FC</b>	No.60K00001 Sheet 2 Of 5	REV. 1
----------------------------------	---------------------------------------	-----------------------------	-----------

## Outside Dimension :

( Unit : mm )

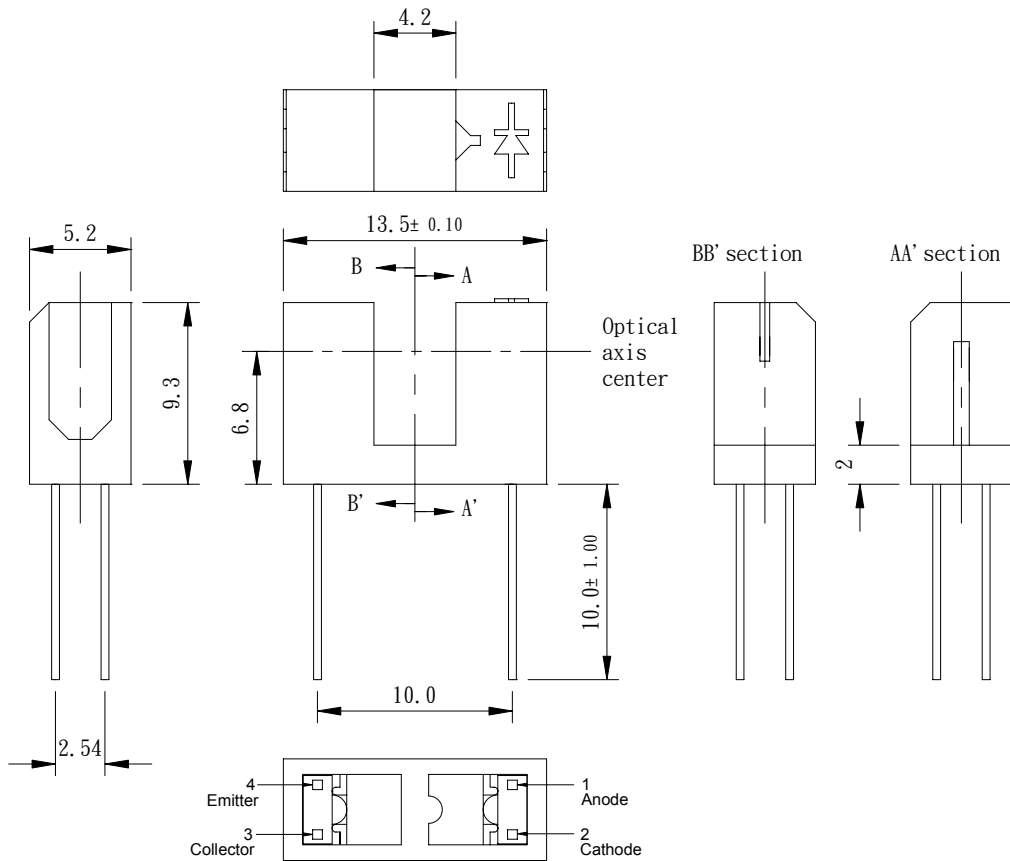

TOLERANCE :  $\pm 0.2$ mm

## Schematic :

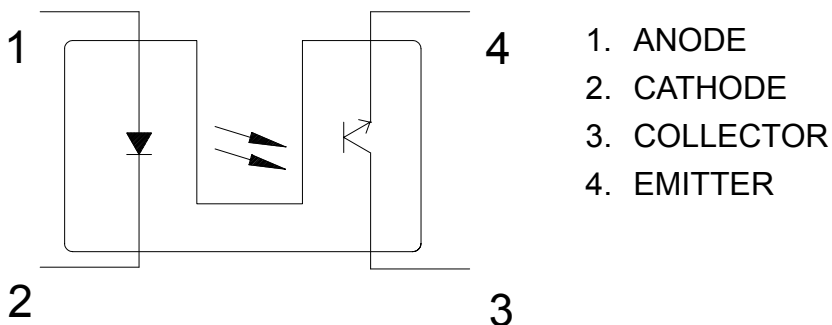

# PRODUCT SPECIFICATION

Date : 2003/12/15

COSMO	Photointerrupter :	No.60K00001	REV.
ELECTRONICS CORPORATION	KW1S50FC	Sheet 3 Of 5	1

## ● Absolute Maximum Ratings

Parameter		Symbol	Rating	Unit
Input	Forward Current	$I_F$	50	mA
	Peak Forward Current <sup>※1</sup>	$I_{FP}$	1	A
	Reverse Voltage	$V_R$	6	V
	Power Dissipation	$P_D$	75	mW
Output	Collector-emitter Voltage	$V_{CEO}$	35	V
	Emitter-collector Voltage	$V_{ECO}$	6	V
	Collector Current	$I_C$	20	mA
	Power Dissipation	$P_D$	75	mW
Total Power Dissipation		$T_{PD}$	100	mW
Operation Temperature		$T_{OPR}$	-25 to +85	°C
Storage Temperature		$T_{STG}$	-40 to +100	°C
Soldering Temperature <sup>※2</sup>		$T_{SOL}$	260	°C

※ 1 Pulse width  $\leq 100\mu s$  , duty ratio=1%

※ 2 For 5 seconds

## ● Electronics Characteristics

Parameter	Symbol	Conditions	Min.	TYP.	MAX.	Unit	
Input	Forward Voltage	$V_F$	$I_F=20mA$	—	1.25	1.4	V
	Peak Forward Voltage	$V_{FM}$	$I_{FM}=0.5A$	—	3	4	V
	Reverse Current	$I_R$	$V_R=3V$	—	—	10	$\mu A$
Output	Collector-emitter dark current	$I_{CEO}$	$V_{CE}=20V, I_F=0mA$	—	1	100	nA
Transfer Characteristics	Collector Current	$I_C$	$V_{CE}=5V, I_F=20mA$	0.5	—	10	mA
	Collector saturation voltage	$V_{CE(SET)}$	$I_F=40mA, I_C=0.5mA$	—	—	0.4	V
	Response time (Rise)	$T_r$	$V_{CE}=2V, I_C=0.5mA$	—	3	15	$\mu s$
	Response time (Fall)	$T_f$	$R_L=100\Omega$	—	4	20	$\mu s$

# PRODUCT SPECIFICATION

Date : 2003/12/15

COSMO ELECTRONICS CORPORATION	Photointerrupter :	No.60K00001	REV. 1
	KW1S50FC		

**Fig. 1 Forward Current vs. Ambient Temperature**

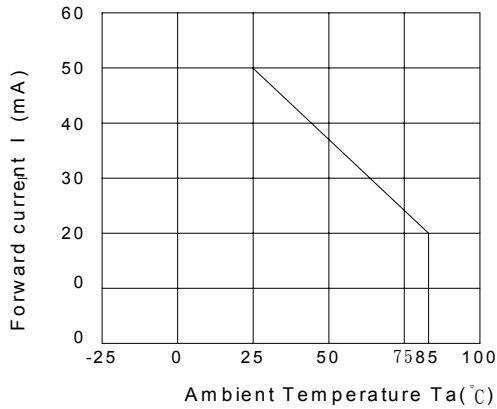

**Fig. 2 Collector Power Dissipation vs. Ambient Temperature**

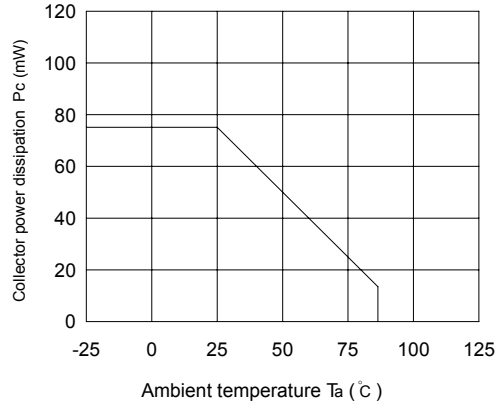

**Fig. 3 Peak Forward Current vs. Duty Ratio**

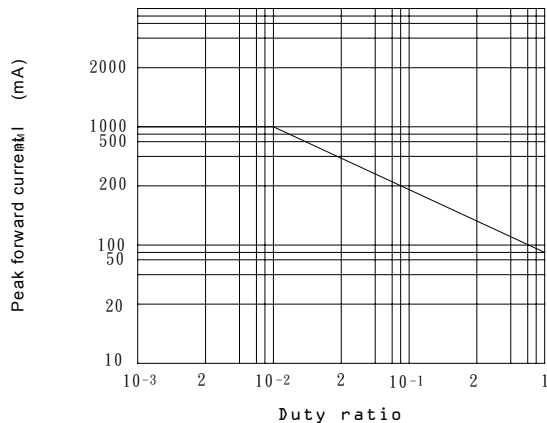

**Fig. 4 Forward Current vs. Forward Voltage**

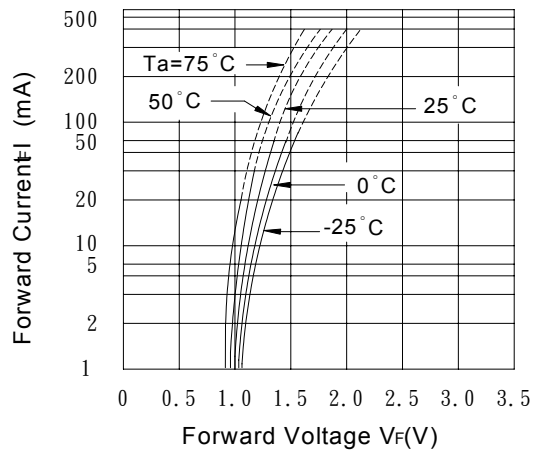

**Fig. 5 Collector Current vs. Forward Current**

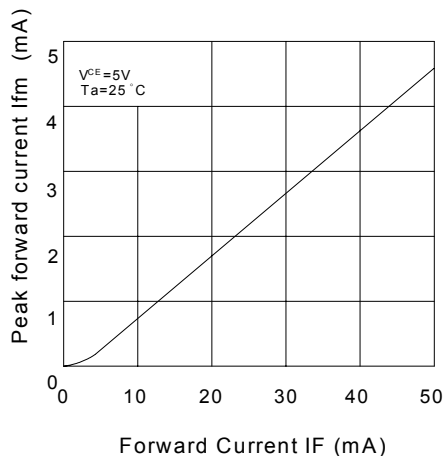

**Fig. 6 Collector Current vs. Collector-emitter Voltage**

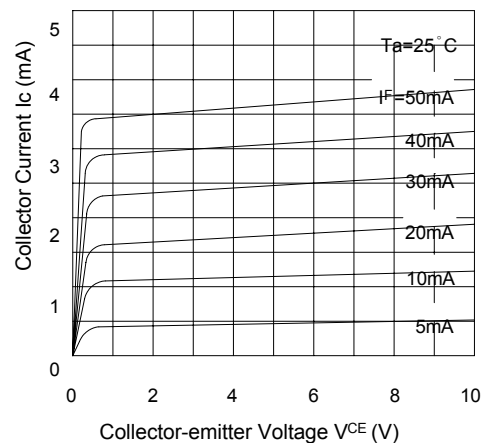

# PRODUCT SPECIFICATION

Date : 2003/12/15

COSMO ELECTRONICS CORPORATION	Photointerrupter :	No.60K00001	REV. 1
	KW1S50FC		

**Fig. 7 Collector Current vs. Ambient Temperature**

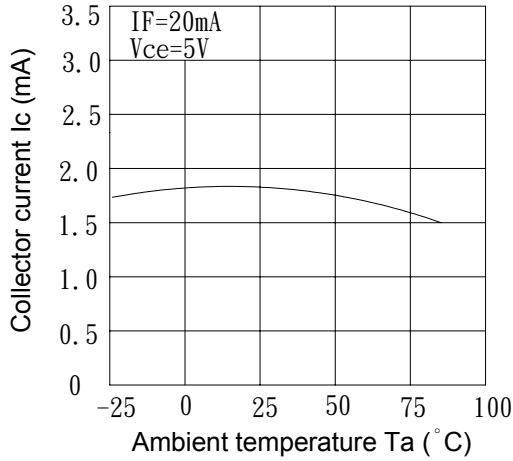

**Fig 8 Collector-emitter Saturation Voltage vs. Ambient Temperature**

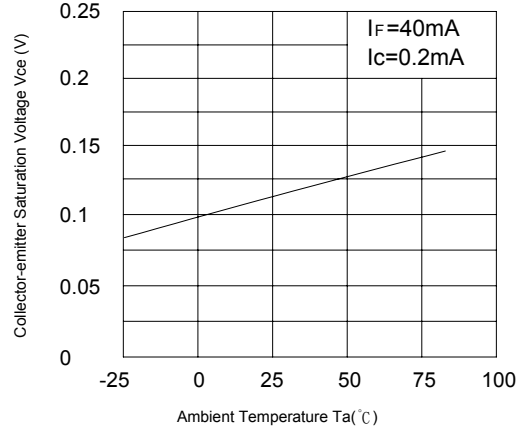

**Fig. 9 Response Time vs. Load Resistance**

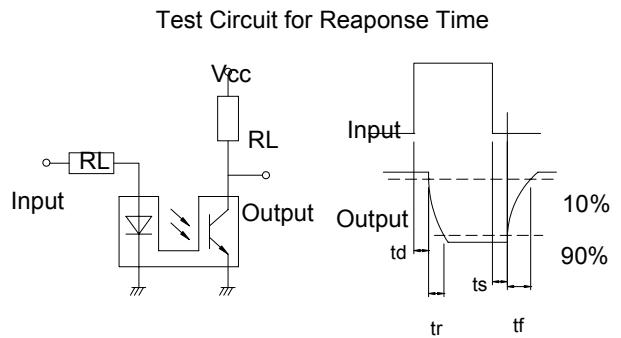
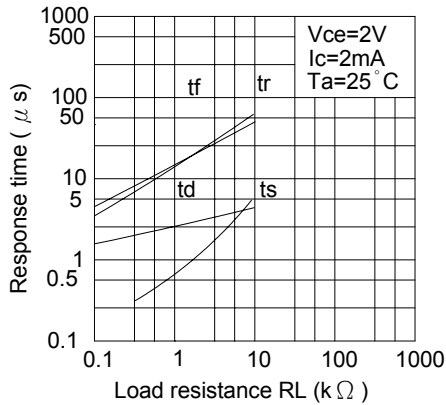

**Fig. 10 Relative Collector Current vs. Shield Distance (1)**

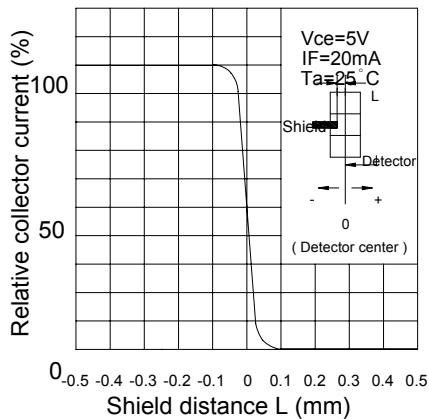

**Fig. 11 Relative Collector Current vs. Shield Distance (2)**

