

## Main Feature

1. 2-pole and 4-pole versions available with switching current at 5 Amps.
2. Printed Circuit Board Terminal, Plug-in Terminal and Flanged Case designed for easy mounting.
3. Low coil power consumption with high response time.
4. High reliability and long life with better vibration and shock resistance.
5. High reliability and long life with better vibration and shock resistance.
6. Touch Button and LED version available.

## Contact Rating

Load Type	RE-2P (DM/DB)	RE-2P (D)	RE-4P (DM/DB)	RE-4P (D)
Rated Load (Resistive)	5A 250VAC	5A 250VAC	5A 250VAC	5A 250VAC
	5A 30VDC	5A 30VDC	5A 30VDC	5A 30VDC
Rated Carrying Current	5A	5A	5A	5A
Max. Allowable Voltage	AC 250V	AC 250V	AC 250V	AC 250V
	DC 110V	DC 110V	DC 110V	DC 110V
Max. Allowable Current	5A	5A	5A	5A
Max. Allowable Power Force	1,250VA	1,250VA	1,250VA	1,250VA
	150W	150W	150W	150W
Contact Material	Ag Alloy	Ag Alloy	Ag Alloy	Ag Alloy
Contact Form	DPST	DPDT	4PST	4PDT

## Application

Vending Machine, Cooking Appliances, Office Machine, Domestic Appliances, Control Equipment... etc.

## Performance (at Initial Value)

- Contact Resistance ..... 100 mΩ Max. @1A,6VDC
- Operate Time..... 25 mSec. Max.
- Release Time ..... 25 mSec. Max.
- Dielectric Strength:
  - Between Coil & Contact..... 1,500VAC at 50/60 Hz for one minute
  - Between Contacts ..... 1,000VAC at 50/60 Hz for one minute
- Surge Strength..... 3,000V (between Coil & Contact 1.2x50μSec.)
- Insulation Resistance ..... 100 MegaΩ Min. at 500VDC
- Max. On/Off Switching:
  - Electrical..... 6 Cycles per Minute
  - Mechanical ..... 300 Cycles per Minute
- Temperature Range..... -25 ~ +55°C
- Humidity Range ..... 45 ~ 85% RH.
- Coil Temperature Rise ..... 60°C Max.
- Vibration:
  - Endurance ..... 10 to 55 Hz dual amplitude width 1.5mm
  - Error Operation..... 10 to 55 Hz dual amplitude width 1.5mm

- Shock:
  - Endurance ..... 1,000 m/S<sup>2</sup> Min.
  - Error Operation..... 100 m/S<sup>2</sup> Min.
- Life Expectancy:
  - Mechanical ..... 10<sup>7</sup> Operations at No Load condition
  - Electrical ..... 10<sup>5</sup> Operations at Rated Resistive Load
- Weight ..... About 2 P : 32 g  
4 P : 35 g

## Accessories & Sockets

- RE-2P
- PYF-08A/AE ..... See Page 173
  - PY-08/-0..... See Page 180
  - PYF-08BE & BE/3 ..... See Page 173
- RE-4P
- PYF-14A/AE ..... See Page 174
  - PY-14/-0..... See Page 180
  - PYF-14BE & BE/3 ..... See Page 174

## Safety Standard & File Number

- UL & C-UL ..... E141060
- VDE ..... 40012699

**Coil Specification (at 20°C)**

Coil Sensitivity	Coil Voltage Code	Nominal Voltage (VAC/VDC)	Nominal Current (mA)		Coil Resistance ( $\Omega \pm 10\%$ )	Power Consumption		Pull-In Voltage	Drop-Out Voltage	Max. Allowable Voltage
			50 Hz	60 Hz		50HZ	60HZ			
RE 2P & 4P AC Coil	01	6	282.67	214.33	10	1.7VA	1.29VA	80% Maximum	30% Minimum	110%
	02	12	106.2	94.85	40	1.27VA	1.14VA			
	03	24	52.8	45.45	160	1.27VA	1.09VA			
	04	48	23.65	19.95	600	1.1VA	0.96VA			
	05	110	12.45	10.25	3,400	1.37VA	1.13VA			
	06	120	16.75	14.33	3,400	2.01VA	1.72VA			
	07	220	6.18	5.08	13,600	1.36VA	1.12VA			
	08	240	7.24	5.85	13,600	1.74VA	1.41VA			
	09	230	7.0	5.7	13,600	1.61VA	1.31VA			
RE 2P & 4P DC Coil	01	6	150		40	Abt. 0.9 W		80% Maximum	10% Minimum	110%
	02	12	75.0		160					
	03	24	36.9		650					
	04	48	18.5		2,600					
	05	110	10.0		11,000					
	06	120	10.9		11,000					
	07	220	5.0		44,000	Abt. 1.1 W				

**Classification**

Model	RE	
Coil Type	AC	
Number Of Poles	2 Poles	4 Poles
Contact Form	RE-2□□A/AM/AB	RE-4□□A/AM/AB
Terminal Type	RE-2□□A/AM/AB RE-2□□AP/AMP/ABP	RE-4□□A/AM/AB RE-4□□AP/AMP/ABP
Case Type	RE-2□□A/AM/AB RE-2□□AF/AMF/ABF	RE-4□□A/AM/AB RE-4□□AF/AMF/ABF
LED	RE-2□□AL/AML/ABL RE-2□□APL/AMPL/ABPL RE-2□□AFL/AMFL/ABFL	RE-4□□AL/AML/ABL RE-4□□APL/AMPL/ABPL RE-4□□AFL/AMFL/ABFL
Touch Button	RE-2□□AT/AMT/ABT RE-2□□APLT/AMPLT/ABPLT RE-2□□AFLT/AMFLT/ABFLT	RE-4□□AT/AMT/ABT RE-4□□APLT/AMPLT/ABPLT RE-4□□AFLT/AMFLT/ABFLT
Europe Type	RE-2□□ALTU/AMLTU/ABLTU RE-2□□APLTU/AMPLTU/ABPLTU	RE-4□□ALTU/AMLTU/ABLTU RE-4□□APLTU/AMPLTU/ABPLTU
Remark	"LTU" were restricted to be together within European Type ordering	

Model	RE	
Coil Type	DC	
Number Of Poles	2 Poles	4 Poles
Contact Form	RE-2□□D/DM/DB	RE-4□□D/DM/DB
Terminal Type	RE-2□□D/DM/DB RE-2□□DP/DMP/DBP	RE-4□□D/DM/DB RE-4□□DP/DMP/DBP
Case Type	RE-2□□D/DM/DB RE-2□□DF/DMF/DBF	RE-4□□D/DM/DB RE-4□□DF/DMF/DBF
LED	RE-2□□DL(Z/Y/X/V)/DML(Z/Y/X/V)/DBL(Z/Y/X/V) RE-2□□DPL(Z/Y/X/V)/(DMPL(Z/Y/X/V)/DBPL(Z/Y/X/V) RE-2□□DFL(Z/Y/X/V)/DMFL(Z/Y/X/V)/DBFL(Z/Y/X/V)	RE-4□□DL(Z/Y/X/V)/DML(Z/Y/X/V)/DBL(Z/Y/X/V) RE-4□□DPL(Z/Y/X/V)/DMPL(Z/Y/X/V)/DBPL(Z/Y/X/V) RE-4□□DFL(Z/Y/X/V)/DMFL(Z/Y/X/V)/DBFL(Z/Y/X/V)
Touch Button	RE-2□□DT/DMT/DBT RE-2□□DPL(Z/Y/X/V)T/DMPL(Z/Y/X/V)T/DBPL(Z/Y/X/V)T RE-2□□DFL(Z/Y/X/V)T/DMFL(Z/Y/X/V)T/DBFL(Z/Y/X/V)T	RE-4□□DT/DMT/DBT RE-4□□DPL(Z/Y/X/V)T/DMPL(Z/Y/X/V)T/DBPL(Z/Y/X/V)T RE-4□□DFL(Z/Y/X/V)T/DMFL(Z/Y/X/V)T/DBFL(Z/Y/X/V)T
Europe Type	RE-2□□DL(Z/Y/X/V)TU/DML(Z/Y/X/V)TU/DBL(Z/Y/X/V)TU RE-2□□DPL(Z/Y/X/V)TU/DMPL(Z/Y/X/V)TU/DBPL(Z/Y/X/V)TU	RE-4□□DL(Z/Y/X/V)TU/DML(Z/Y/X/V)TU/DBL(Z/Y/X/V)TU RE-4□□DPL(Z/Y/X/V)TU/DMPL(Z/Y/X/V)TU/DBPL(Z/Y/X/V)TU
Remark	"LTU" were restricted to be together within European Type ordering	



Dimension ( $\leq 5\text{mm} \pm 0.2\text{mm}$ ,  $> 5\text{mm} \pm 0.3\text{mm}$ , the tolerance of PCB thru hole:  $+0.1\text{mm}$ )

RE-2

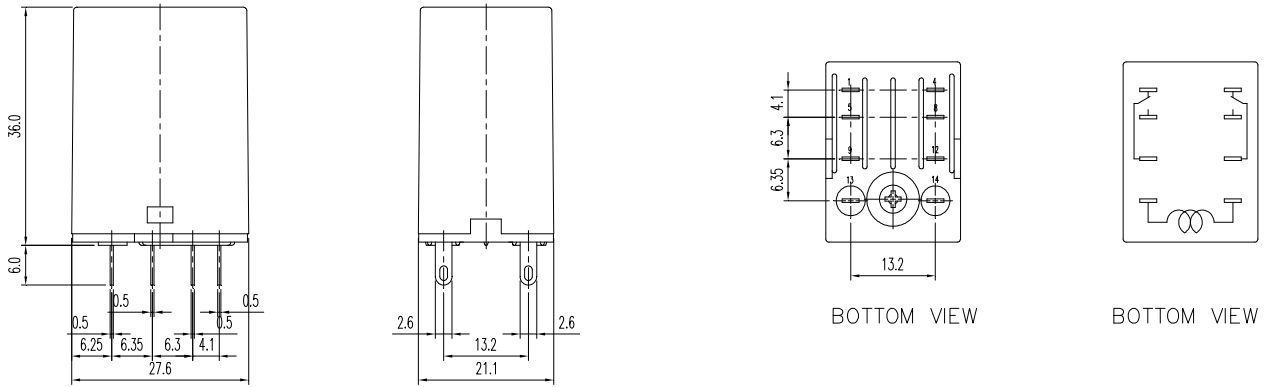

RE-2-F

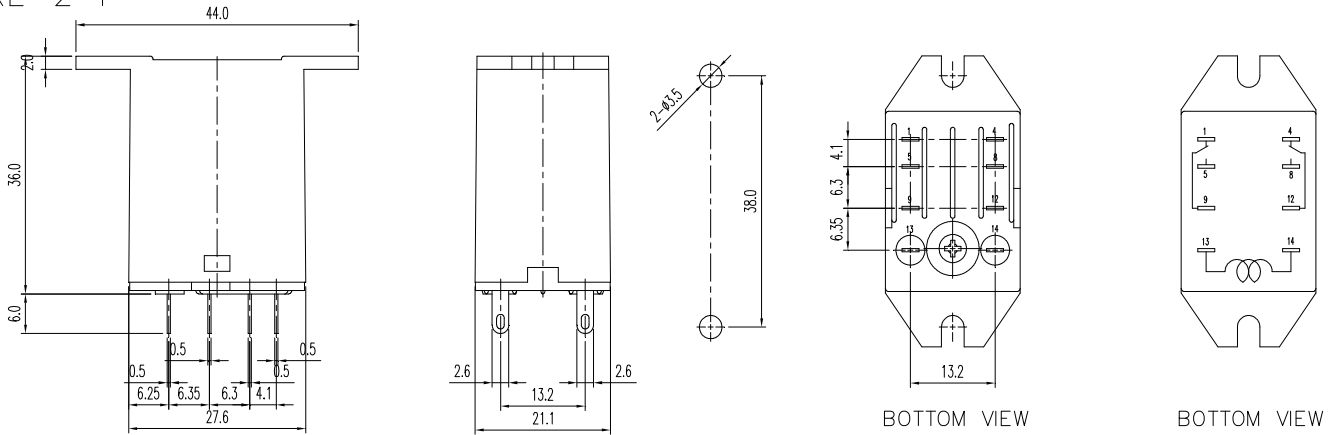

RE-2-P

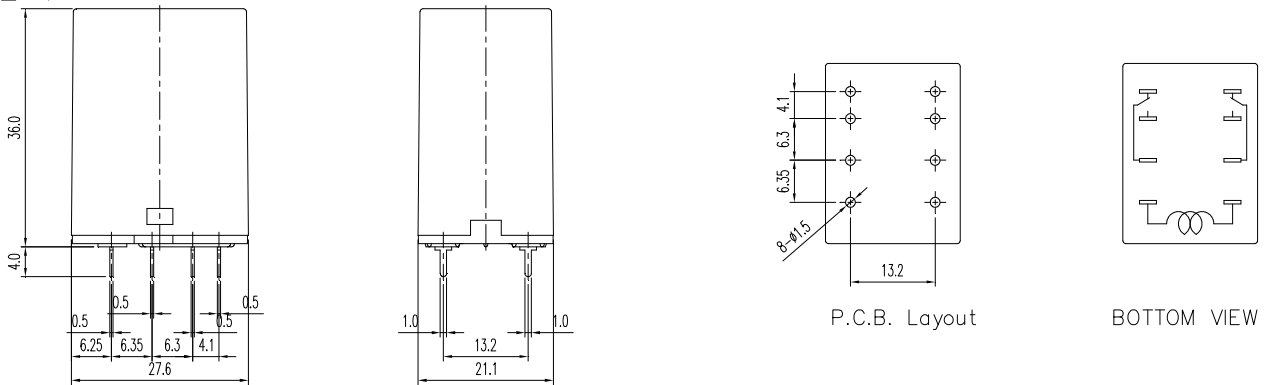

RE-2xxU

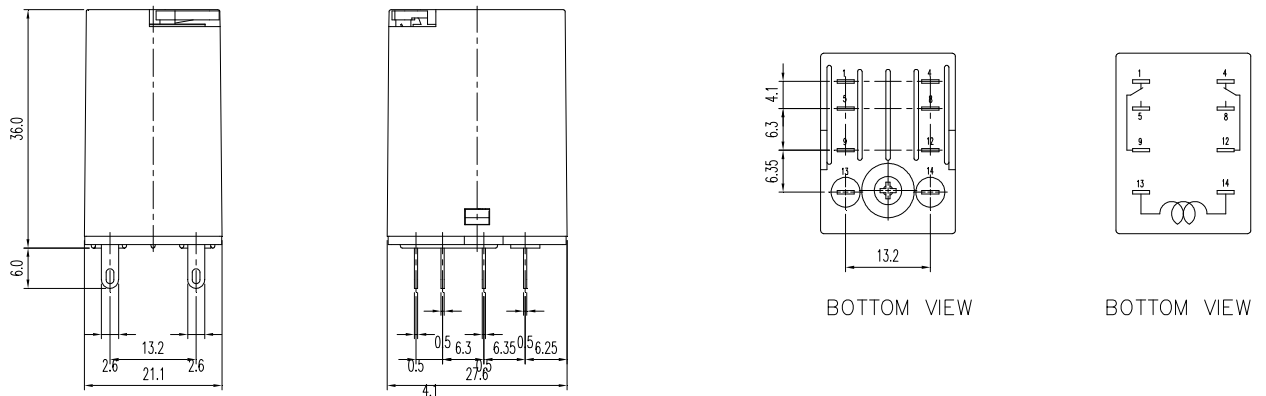

# RE

RE-4

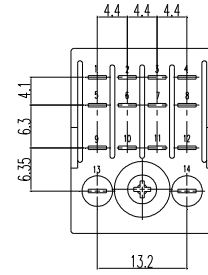
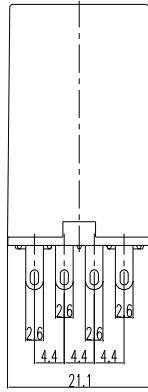
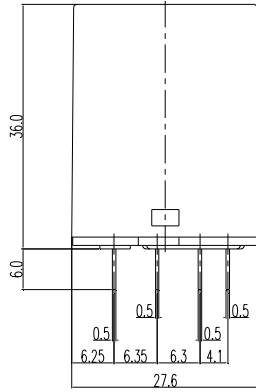

BOTTOM VIEW

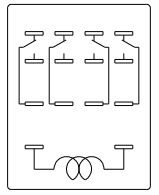

BOTTOM VIEW

RE-4-F

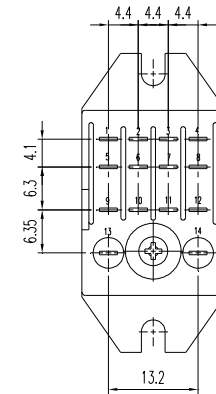
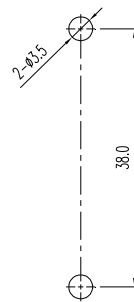
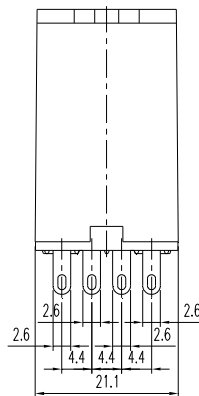
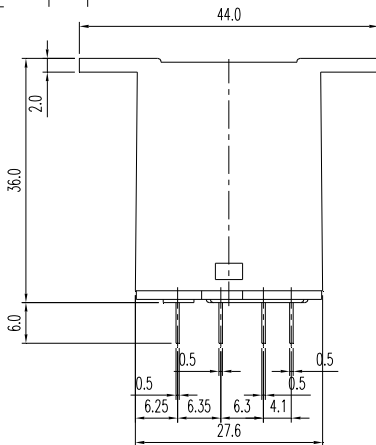

BOTTOM VIEW

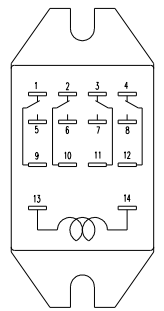

BOTTOM VIEW

RE-4-P

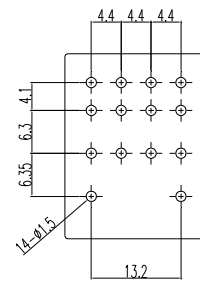
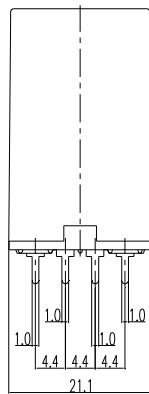
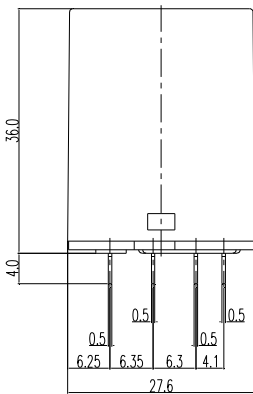

P.C.B. Layout

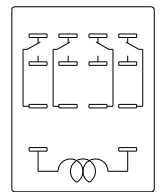

BOTTOM VIEW

RE-4xxU

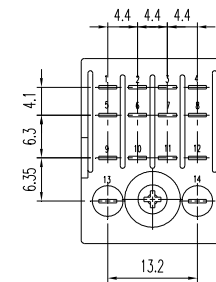
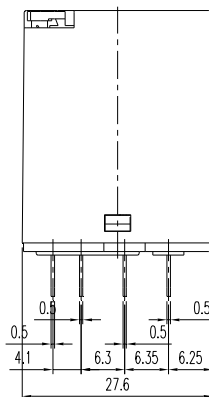
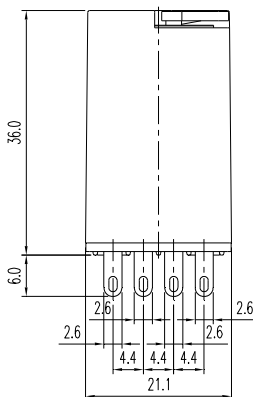

BOTTOM VIEW

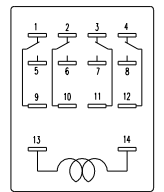

BOTTOM VIEW

Wiring diagrams (Bottom view)

RE-2P		
RE-2□D□□□L□□□	RE-2□D□□□X□□□	RE-2□D□□□V□□□
RE-2□D□□□Z□□□	RE-2□D□□□Y□□□	AC Coil Model With LED
RE-4P		
RE-4□D□□□L□□□	RE-4□D□□□X□□□	RE-4□D□□□V□□□
RE-4□D□□□Z□□□	RE-4□D□□□Y□□□	AC Coil Model With LED